

# PVC-U DOOR COLLECTION

## TECHNICAL SPECIFICATION GUIDE



# CONTENTS

## PVC-U DOOR PANELS

Acacia	Page 2	Sandringham	Page 26
Alnwick	Page 2	Sandringham Side	Page 27
Amalfi	Page 3	Seville	Page 27
Althorpe	Page 3	Sorrento	Page 28
Balmoral	Page 4	Turin	Page 28
Balmoral Classic	Page 4	Wendland	Page 29
Balmoral Classic Side	Page 5	Windsor	Page 30
Blenheim	Page 5		
Bruges	Page 6		
Cambridge	Page 6		
Capri	Page 7	Half Panels	Page 31
Canterbury	Page 7	Quarter Panels	Page 33
Canterbury Side	Page 8	Conservatory Panels	Page 35
Canton	Page 8	Flat Panels	Page 39
Chatsworth	Page 9		
Clarence	Page 9		
Como	Page 10	MDF and Thickness Options	Page 39
Hamburg	Page 10	Ancillaries	Page 40
Harewood	Page 11	Glass Guide	Page 41
Highgrove	Page 11	Backing Glass Options	Page 42
Kensington	Page 12	Colour/Woodgrain Options	Page 43
Madrid	Page 13	Notes	Page 44
Malaga	Page 14		
Milan	Page 14		
Moderns	Page 15-20		
Monaco	Page 21		
Munich	Page 21		
Oval	Page 22		
Oxford	Page 22		
Portofino	Page 23		
Provence	Page 23		
Reims	Page 24		
Richmond	Page 25		
Rockingham	Page 25		
Rome	Page 26		

# ACACIA

ACACIA SOLID INVERTED

ACACIA ONE INVERTED

**Please Note;**

- Not available with solid MDF reinforcing
- 20mm thickness not available

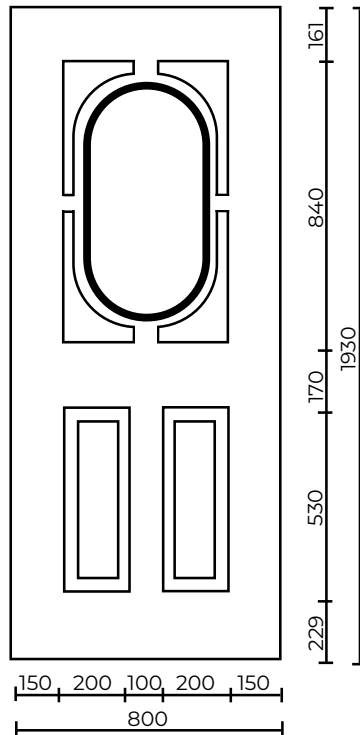

Minimum Cut Size

550mm x 1590mm

Glass Size

252mm x 584mm

Sight Line

217mm x 555mm

# ALNWICK

ALNWICK SOLID

ALNWICK ONE

ALNWICK ONE INVERTED

**Please Note;**

- Not available with solid MDF reinforcing (inverted)
- 20mm thickness not available

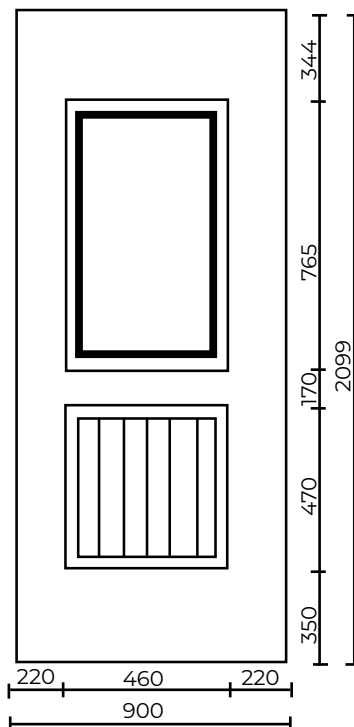

Minimum Cut Size

510mm x 1455mm

Glass Size Standard

390mm x 693mm

Glass Size Inverted

397mm x 702mm

Sight Line Standard

350mm x 655mm

Sight Line Inverted

370mm x 673mm

# AMALFI

- AMALFI SOLID
- AMALFI FOUR

**Please note;**

- This panel is not available with solid MDF reinforcing
- 8mm groove depth

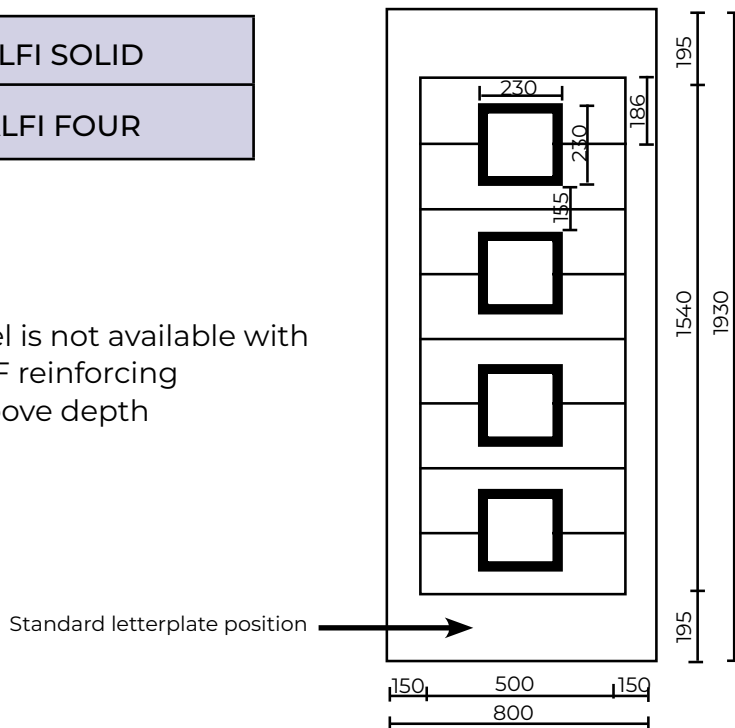

- Minimum Cut Size
- 550mm x 1606mm\*

\*Minimum height 1720mm with letterplate (bottom only)

- Glass Size
- 170mm x 170mm
- Sight Line
- 144mm x 144mm

# ALTHORPE

- ALTHORPE SOLID OVAL INVERTED
- ALTHORPE ONE INVERTED
- ALTHORPE ONE OVAL INVERTED

**Please Note;**

- Not available with solid MDF reinforcing
- 20mm thickness not available

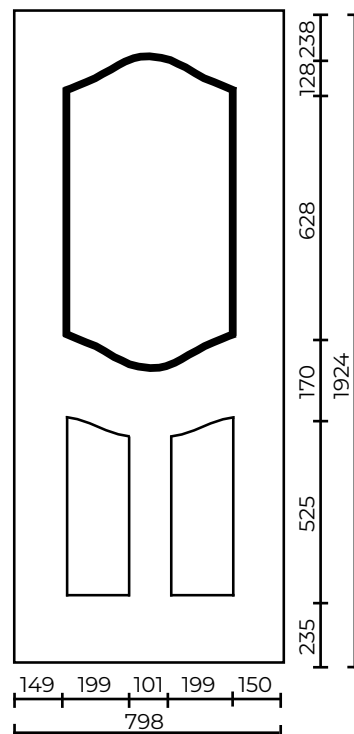

- Minimum Cut Size
- 550mm x 1510mm

- Glass Size Oval Inverted
- 325mm x 585mm

- Glass Size Inverted
- 440mm x 830mm

- Sight Line Oval Inverted
- 310mm x 570mm

- Sight Line Inverted
- 410mm x 800mm

# BALMORAL SMALL APERTURE

- BALMORAL SMALL SOLID
- BALMORAL ONE SMALL
- BALMORAL TWO SMALL

**Please Note;**

- Also available in Euro size - 900mm x 2100mm

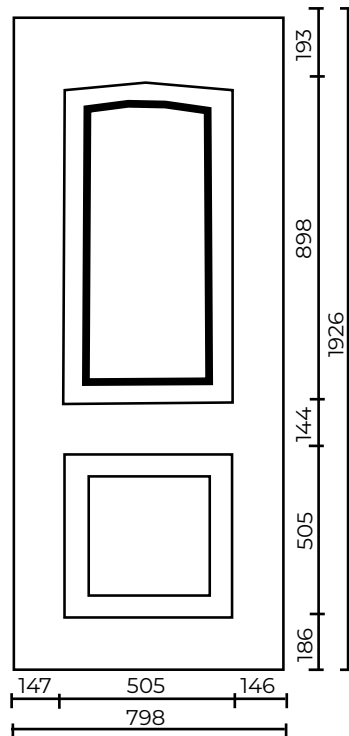

- Minimum Cut Size  
550mm x 1595mm
- Glass Size Top  
315mm x 705mm
- Glass Size Bottom  
315mm x 315mm
- Sight Line Top  
285mm x 675mm
- Sight Line Bottom  
285mm x 285mm

# BALMORAL CLASSIC (LARGE APERTURE)

- BALMORAL ONE LARGE
- BALMORAL TWO LARGE

**Please note;**

- Also available in Euro size - 900mm x 2100mm
- Bottom moulding matches Hanover

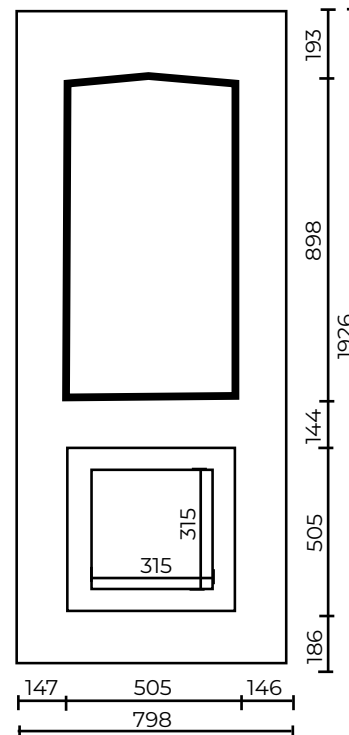

- Minimum Cut Size  
550mm x 1595mm
- Glass Size Top  
445mm x 840mm
- Glass Size Bottom  
445mm x 445mm
- Sight Line Top  
410mm x 805mm
- Sight Line Bottom  
410mm x 410mm

# BALMORAL CLASSIC SIDE

- BALMORAL SOLID SIDE
- BALMORAL ONE LARGE SIDE
- BALMORAL TWO LARGE SIDE

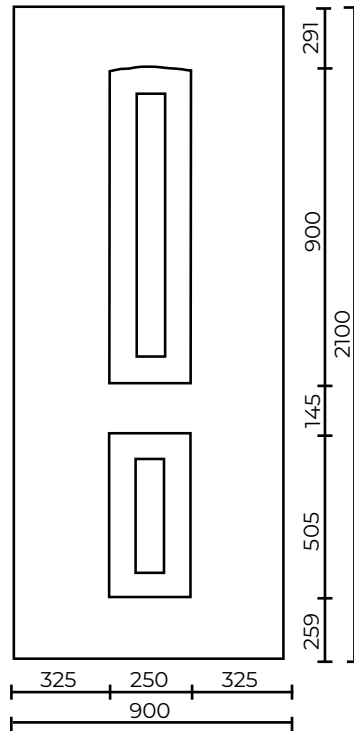

Minimum Cut Size
300mm x 1595mm

Glass Size Top
185mm x 845mm

Glass Size Bottom
185mm x 440mm

Sight Line Top
150mm x 805mm

Sight Line Bottom
150mm x 400mm

# BLENHEIM

- BLENHEIM SOLID
- BLENHEIM ONE

Please note;

- Georgian Bar not available
- Knocker will fit under glass

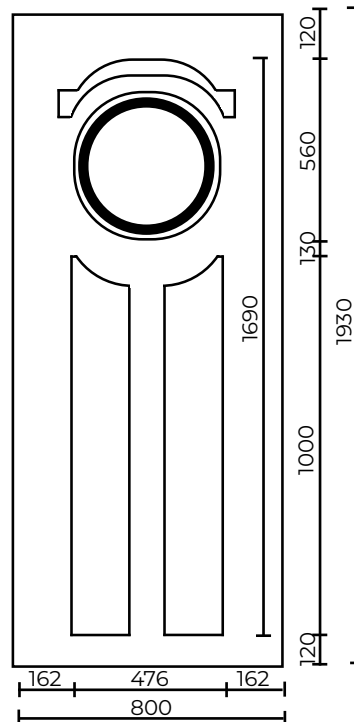

Minimum Cut Size
526mm x 1740mm

Glass Size
420mm x 420mm

Sight Line
390mm x 390mm

# BRUGES

BRUGES SOLID
BRUGES TWO
BRUGES EIGHT

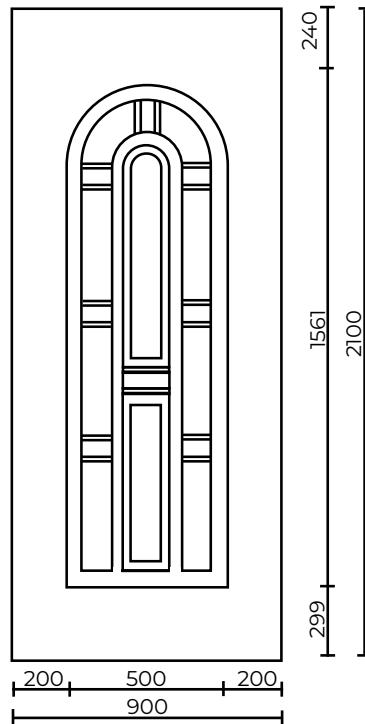

Minimum Cut Size
550mm x 1610mm

Glass Size Top
425mm x 226mm
Glass Size Middle
110mm x 1185mm

# CAMBRIDGE

CAMBRIDGE GEORGIAN BOW FRONTED
-----------------------------------

**Please note;**

- One sealed glass unit
- Each rectangle is 110mm x 200mm
- Projection is 33mm
- 20mm not advised due to the weight of the unit

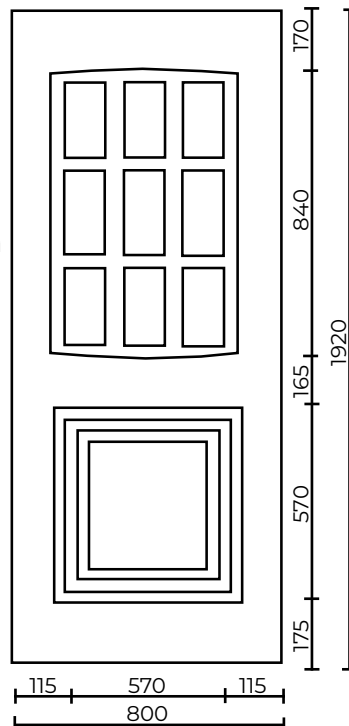

Minimum Cut Size
620mm x 1625mm

Glass Size
500mm x 770mm
Sight Line
100mm x 190mm

# CAPRI

CAPRI SOLID
CAPRI ONE

**Please note;**

- This panel is not available with solid MDF reinforcing
- 8mm groove depth

Standard letterplate position →

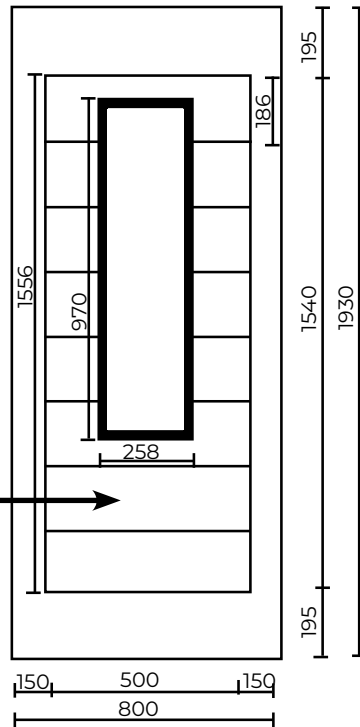

Minimum Cut Size
550mm x 1606mm*

\*Minimum height 1720mm with letterplate (bottom only)

Glass Size
203mm x 912mm

Sight Line
165mm x 876 mm

# CANTERBURY

CANTERBURY SOLID
CANTERBURY ONE

**Please note;**

- Also available in Euro size - 900mm x 2100mm
- This panel must be reinforced
- Square Lead - 140mm x 200mm
- 20mm thickness not available

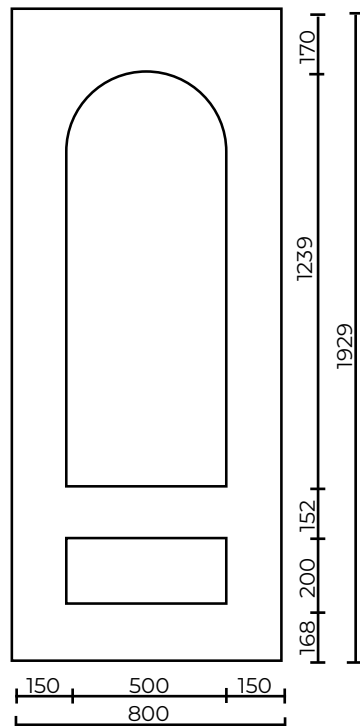

Minimum Cut Size
550mm x 1640mm

Glass Size - Arched
437mm x 1180mm

Sight Line - Arched
400mm x 1135mm

# CANTERBURY SIDE

CANTERBURY SOLID SIDE  
 CANTERBURY ONE SIDE

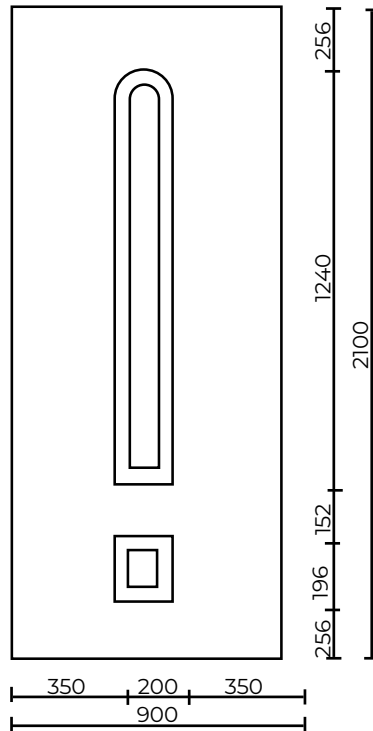

Minimum Cut Size  
 250mm x 1640mm

Glass Size - Arched  
 130mm x 1175mm

Sight Line - Arched  
 95mm x 1140mm

# CANTON

CANTON SOLID  
 CANTON ONE

Please note;

- Georgian Bar available as a cross

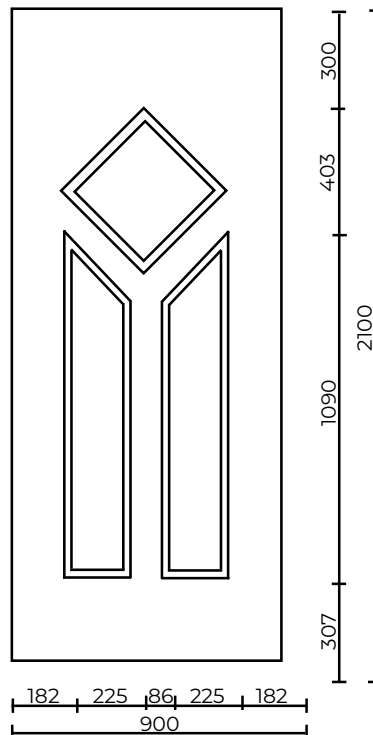

Minimum Cut Size  
 590mm x 1685mm

Glass Size  
 295mm x 295mm

Sight Line  
 270mm x 270mm

# CHATSWORTH

CHATSWORTH SOLID  
CHATSWORTH ONE

**Please note;**

- Grooves do not match Shiplap
- Groove Depth 5mm
- Panel not available with solid MDF reinforcing

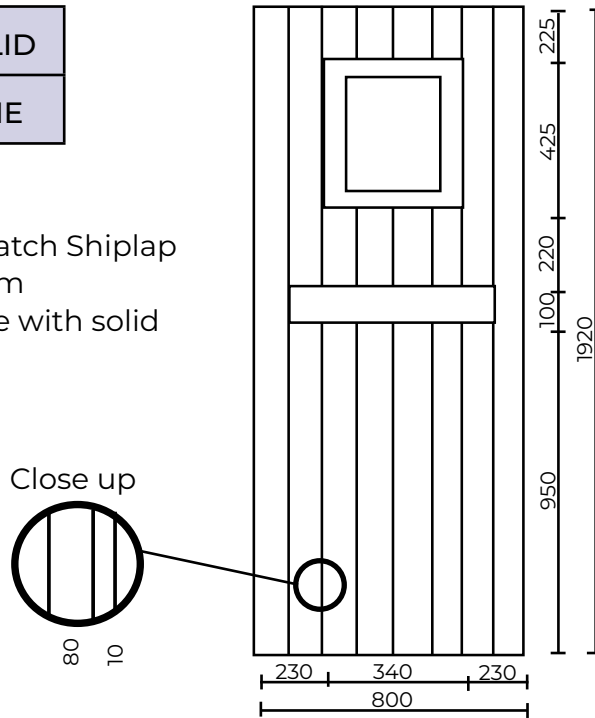

Minimum Cut Size  
390mm x 795mm

Minimum Cut Size Top  
475mm x 475mm

Glass Size  
290mm x 375mm

Sight Line  
260mm x 338mm

# CLARENCE

CLARENCE INVERTED SOLID  
CLARENCE TWO INVERTED

**Please note;**

- This panel is not available with solid MDF reinforcing

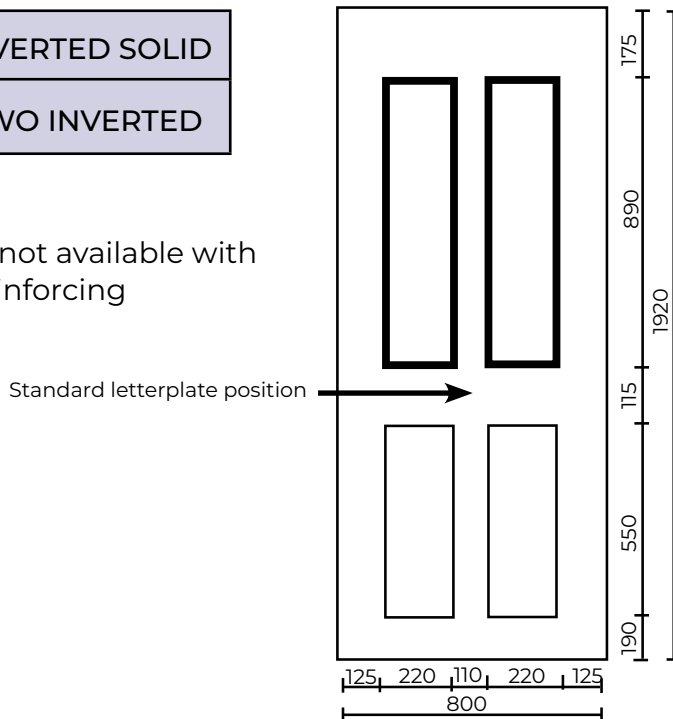

Minimum Cut Size  
600mm x 1605mm

Glass Size  
140mm x 812mm

Sight Line  
115mm x 787mm

# COMO

COMO SOLID
COMO ONE

**Please note;**

- This panel is not available with solid MDF reinforcing

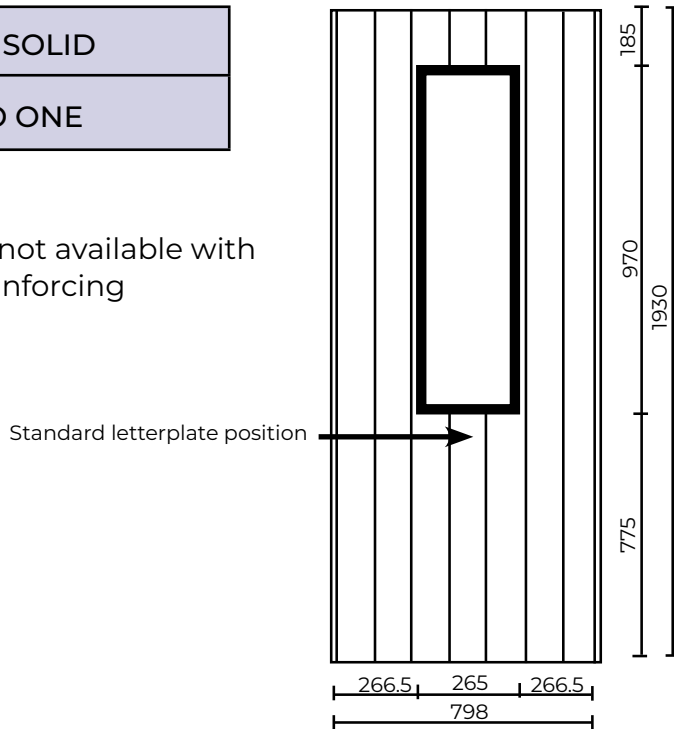

Minimum Cut Size
315mm x 1020mm*

\*Minimum height 1150mm with letterplate (Under glass)

Glass Size
203mm x 912mm

Sight Line
169mm x 875mm

# HAMBURG

HAMBURG SOLID
HAMBURG ONE

**Please note;**

- Not available with solid MDF reinforcing
- Georgian Bar available as a cross

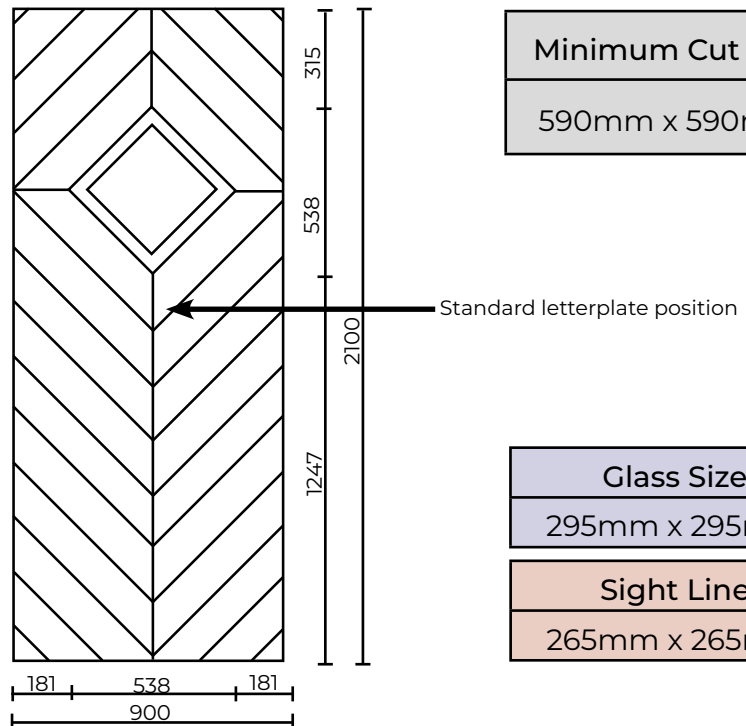

Minimum Cut Size
590mm x 590mm

Glass Size
295mm x 295mm

Sight Line
265mm x 265mm

# HAREWOOD

HAREWOOD SOLID

HAREWOOD ONE

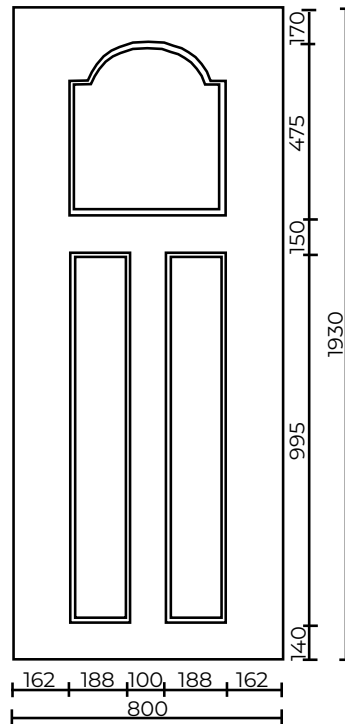

Minimum Cut Size

526mm x 1670mm

Glass Size

445mm x 445mm

Sight Line

395mm x 390mm

# HIGHGROVE

HIGHGROVE SOLID

HIGHGROVE ONE

HIGHGROVE TWO

Please note;

- Also available in Euro size - 900mm x 2100mm

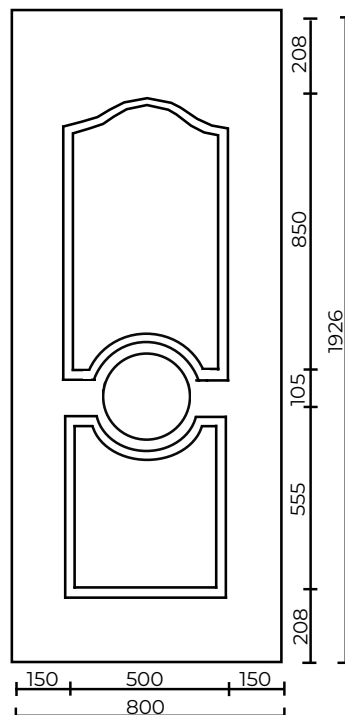

Minimum Cut Size

550mm x 1550mm

Glass Size Top

405mm x 760mm

Glass Size Bottom

403mm x 466mm

Sight Line Top

365mm x 625mm

Sight Line Bottom

365mm x 420mm

# KENSINGTON

- KENSINGTON SOLID
- KENSINGTON TWO
- KENSINGTON FOUR

**Please note;**

- Also available in Euro size - 900mm x 2100mm
- Available inverted except Euro size and Kensington 4
- Mouldings match Manor panels
- 20mm thickness not available in inverted
- Solid MDF not available in inverted

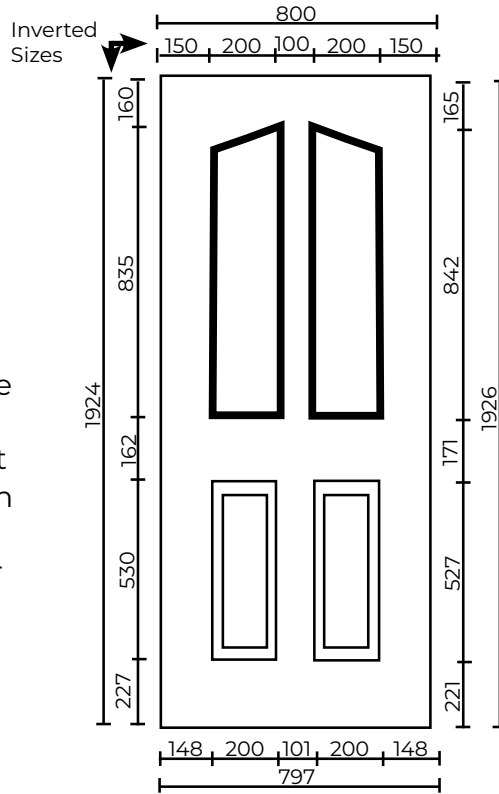

**Minimum Cut Size**  
550mm x 1590mm

**Glass Size Top**  
135mm x 770mm

**Glass Size Bottom**  
135mm x 465mm

**Sight Line Top**  
110mm x 740/710mm

**Sight Line Bottom**  
110mm x 438mm

# KENSINGTON SIDE

- KENSINGTON SOLID SIDE
- KENSINGTON ONE SIDE
- KENSINGTON TWO SIDE

**Please note;**

- Not available inverted

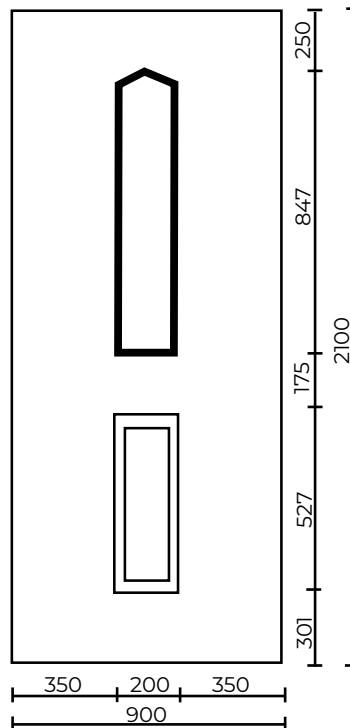

**Minimum Cut Size**  
250mm x 1599mm

**Glass Size Top**  
140mm x 790mm

**Glass Size Bottom**  
135mm x 465mm

**Sight Line Top**  
112mm x 755mm

**Sight Line Bottom**  
110mm x 438mm

# MADRID

- MADRID SOLID
- MADRID TWO

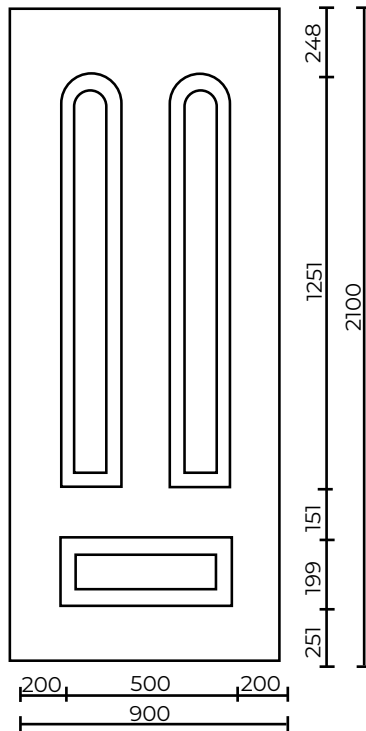

- Minimum Cut Size
- 550mm x 1651mm

- Glass Size
- 130mm x 1175mm
- Sight Line
- 95mm x 1140mm

# MADRID SIDE

- MADRID SOLID SIDE
- MADRID ONE SIDE

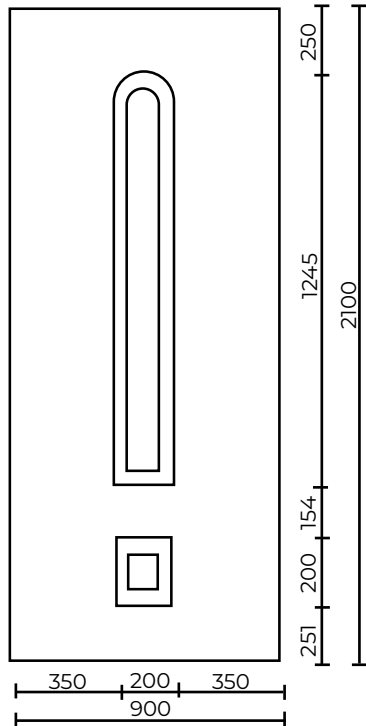

- Minimum Cut Size
- 250mm x 1649mm

- Glass Size
- 130mm x 1175mm
- Sight Line
- 95mm x 1140mm

# MALAGA

- MALAGA SOLID
- MALAGA FIVE

Please note;

- One sealed glass unit not individual pieces

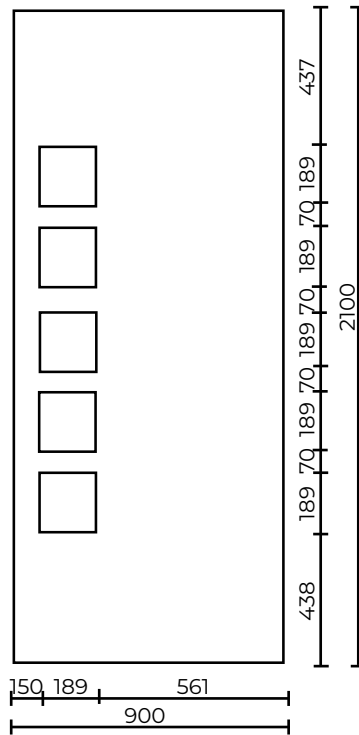

- Minimum Cut Size
- 239mm x 1275mm\*

\*Minimum width of 560mm if letterplate to the side

- Glass Size
- 130mm x 1175mm
- Sight Line
- 95mm x 90mm x5

# MILAN

- MILAN SOLID
- MILAN ONE

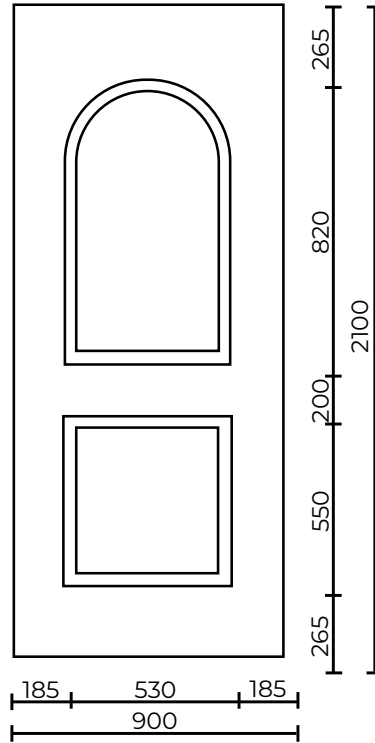

- Minimum Cut Size
- 580mm x 1620mm

- Glass Size
- 432mm x 730mm

# MODERN 5101

## MODERN 5101

**Please note;**

- 40mm trims will be included on both sides of the panel

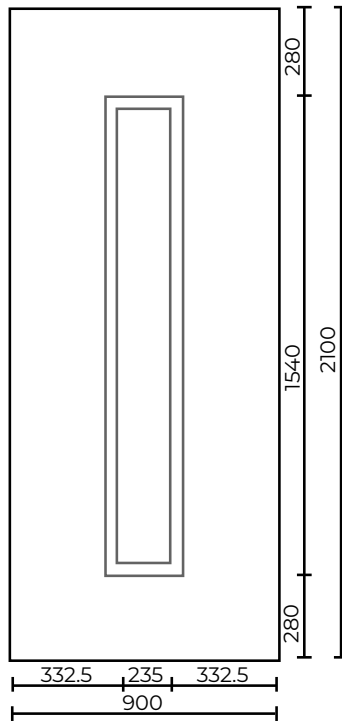

Minimum Cut Size
285mm x 1590mm*

\*Minimum height of 1705mm with a letterplate

Glass Size
180mm x 1485mm
Sight Line
155mm x 1460

# MODERN 5123

## MODERN 5123

**Please note;**

- 40mm trims will be included on both sides of the panel
- 20mm thickness not available

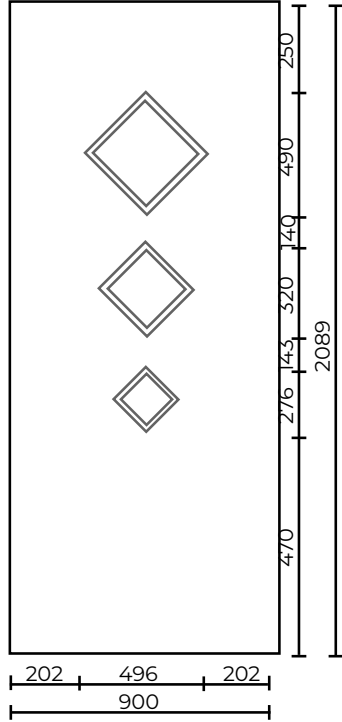

Minimum Cut Size
546mm x 1424mm

Glass Size Top
295mm x 295mm

Glass Size Middle
175mm x 175mm

Glass Size Bottom
140mm x 140mm

Sight Line Top
270mm x 270mm

Sight Line Middle
144mm x 144mm

Sight Line Bottom
114mm x 114mm

## MODERN 5082

### MODERN 5082

**Please note;**

- 40mm trims will be included on both sides of the panel

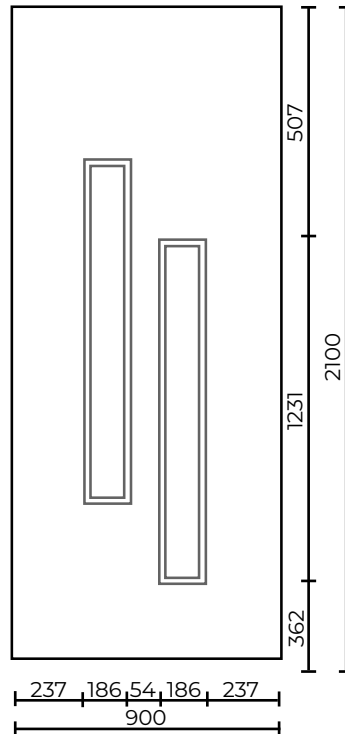

### Minimum Cut Size

476mm x 1426mm

### Glass Size

130mm x 1175mm

### Sight Line

104mm x 1150mm

## MODERN 5113

### MODERN 5113

**Please note;**

- 40mm trims will be included on both sides of the panel
- 20mm thickness not available

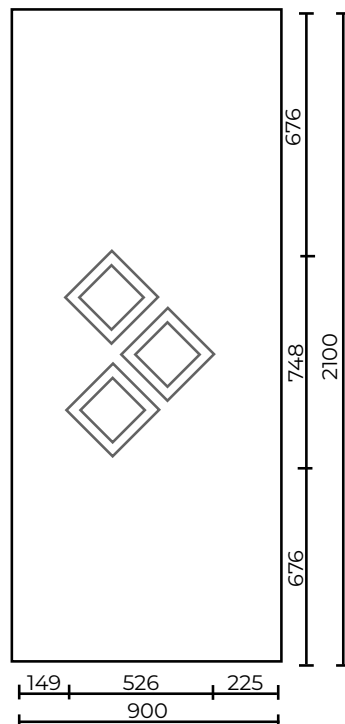

### Minimum Cut Size

576mm x 798mm

### Glass Size

175mm x 175mm

### Sight Line

144mm x 144mm

## MODERN 5013

### MODERN 5013

**Please note;**

- 40mm trims will be included on both sides of the panel

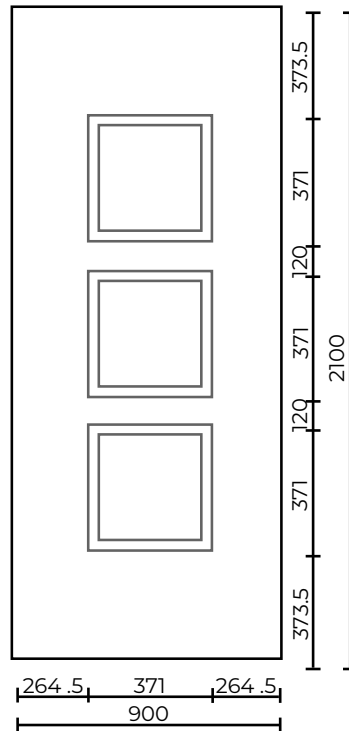

### Minimum Cut Size

421mm x 1403mm

### Glass Size

315mm x 315mm

### Sight Line

290mm x 290mm

## MODERN 5034

### MODERN 5034

**Please note;**

- 40mm trims will be included on both sides of the panel
- 20mm thickness not available
- Knocker won't fit between trims

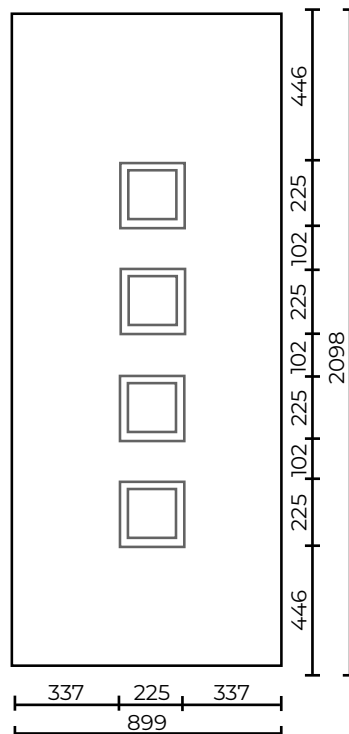

### Minimum Cut Size

276mm x 1254mm

### Glass Size

170mm x 170mm

### Sight Line

144mm x 144mm

# MODERN 5051

## MODERN 5051

Please note;

- 40mm trims will be included on both sides of the panel

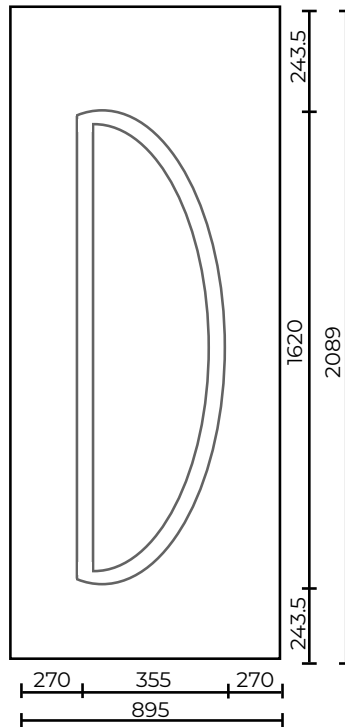

## Minimum Cut Size

405mm x 1670mm

## Glass Size

300mm x 1450mm

## Sight Line

275mm x 1420mm

# MODERN 5162

## MODERN 5162

Please note;

- 40mm trims will be included on both sides of the panel

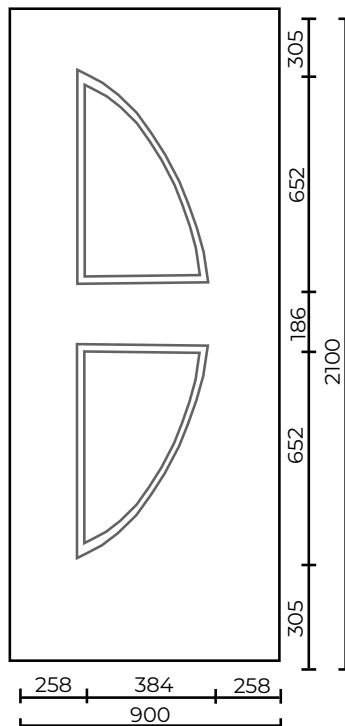

## Minimum Cut Size

434mm x 1540mm

## Glass Size

345mm x 590mm

## Sight Line

295mm x 530mm

# MODERN 5071

## MODERN 5071

Please note;

- 40mm trims will be included on both sides of the panel

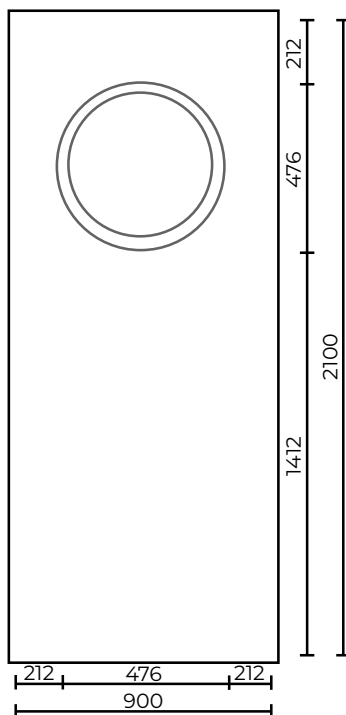

<b>Minimum Cut Size</b>
526mm x 526mm

<b>Glass Size</b>
420mm x 420mm

<b>Sight Line</b>
390mm x 390mm

# MODERN 5131

## MODERN 5131

Please note;

- 40mm trims will be included on both sides of the panel

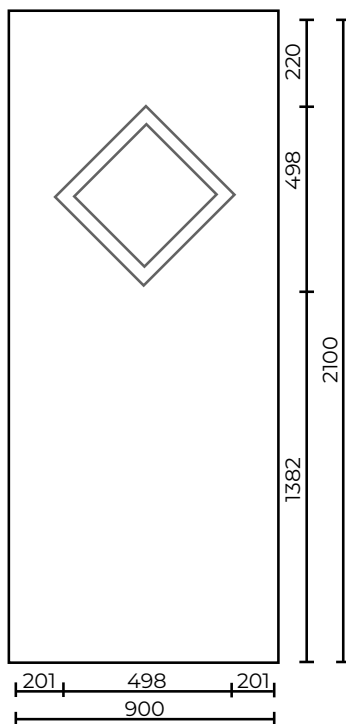

<b>Minimum Cut Size</b>
548mm x 548mm

<b>Glass Size</b>
295mm x 295mm

<b>Sight Line</b>
266mm x 266mm

## MODERN 5141

### MODERN 5141

Please note;

- 40mm trims will be included on both sides of the panel

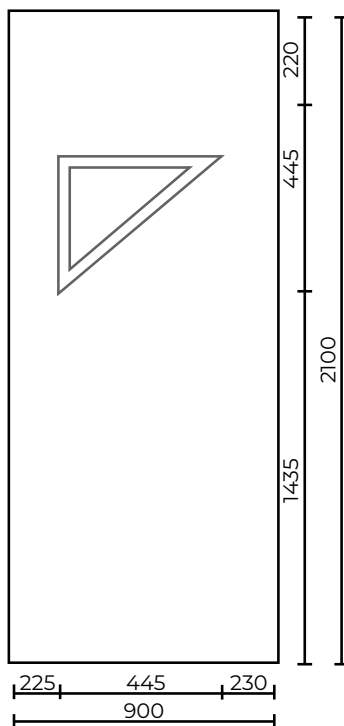

### Minimum Cut Size

495mm x 495mm

### Glass Size

350mm x 487mm

### Sight Line

304mm x 430mm

## MODERN 5171

### MODERN 5171

Please note;

- 40mm trims will be included on both sides of the panel

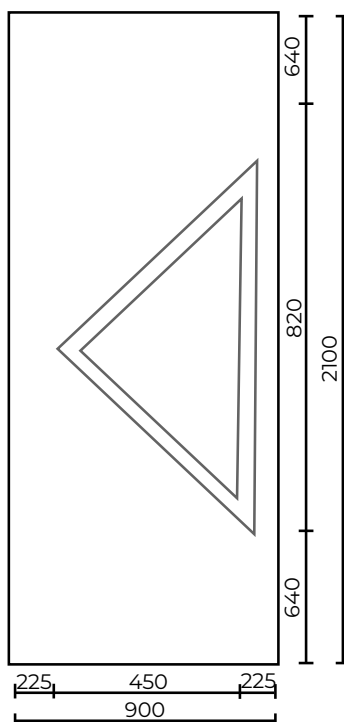

### Minimum Cut Size

500mm x 870mm

### Glass Size

540mm x 540mm

# MONACO

MONACO SOLID RIGHT
MONACO SOLID LEFT
MONACO ONE RIGHT
MONACO ONE LEFT

**Please note;**

- This panel is not available with solid MDF reinforcing
- 8mm groove depth

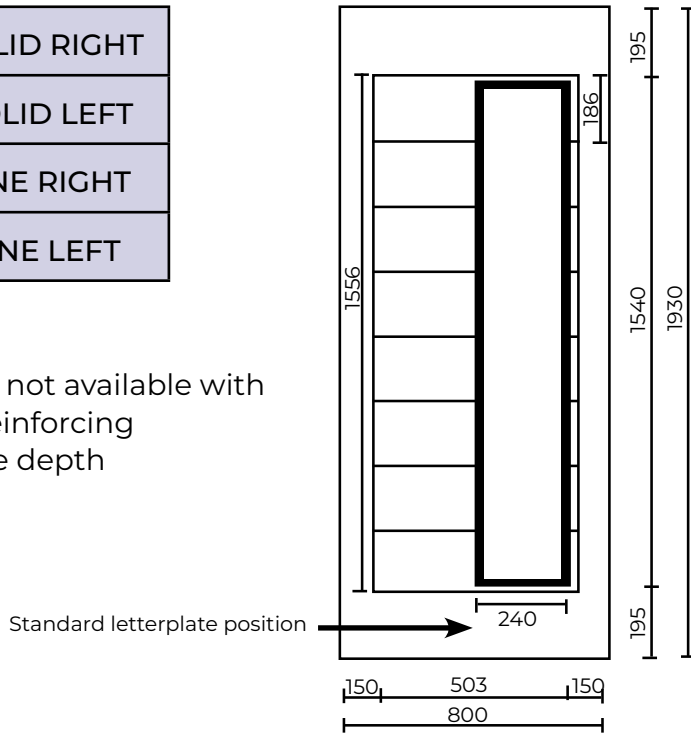

Minimum Cut Size
553mm x 1606mm*

\*Minimum height 1720mm with letterplate (bottom only)

Glass Size
180mm x 1485mm

Sight Line
135mm x 1425mm

# MUNICH

MUNICH SOLID
MUNICH ONE
MUNICH TWO

**Please note;**

- This panel is not available with solid MDF reinforcing
- 10mm groove depth

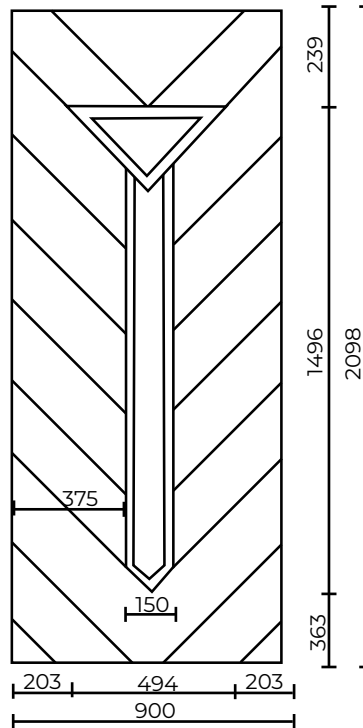

Minimum Cut Size
544mm x 1550mm

Glass Size
180mm x 1485mm

Sight Line
160mm x 1450mm

# OVAL

OVAL ONE

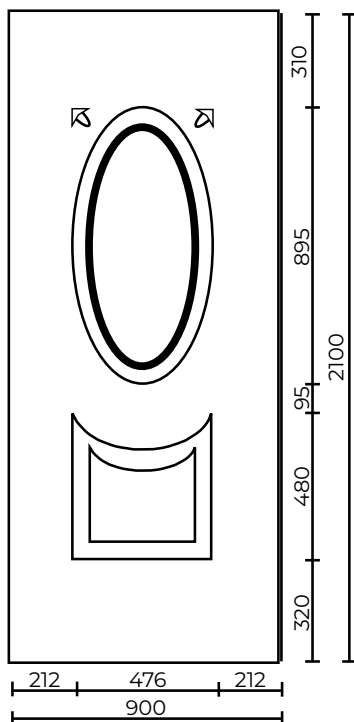

Minimum Cut Size  
526mm x 1510mm

Glass Size  
425mm x 837mm

# OXFORD

OXFORD SOLID  
OXFORD ONE

Please note;

- Also available in Euro size - 900mm x 2100mm

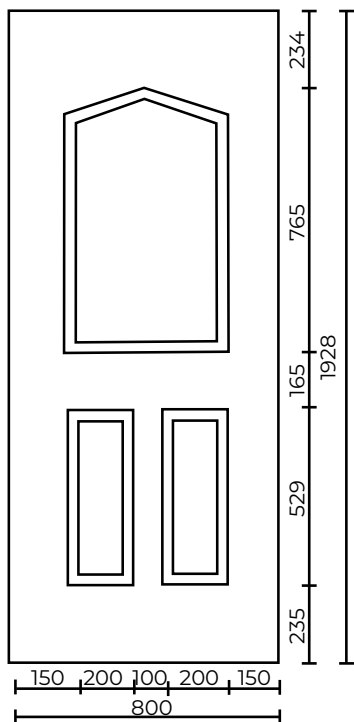

Minimum Cut Size  
550mm x 1510mm

Glass Size  
445mm x 710mm

Sight Line  
406mm x 670mm

# PORTOFINO

- PORTOFINO SOLID
- PORTOFINO THREE

**Please note;**

- This panel is not available with solid MDF reinforcing

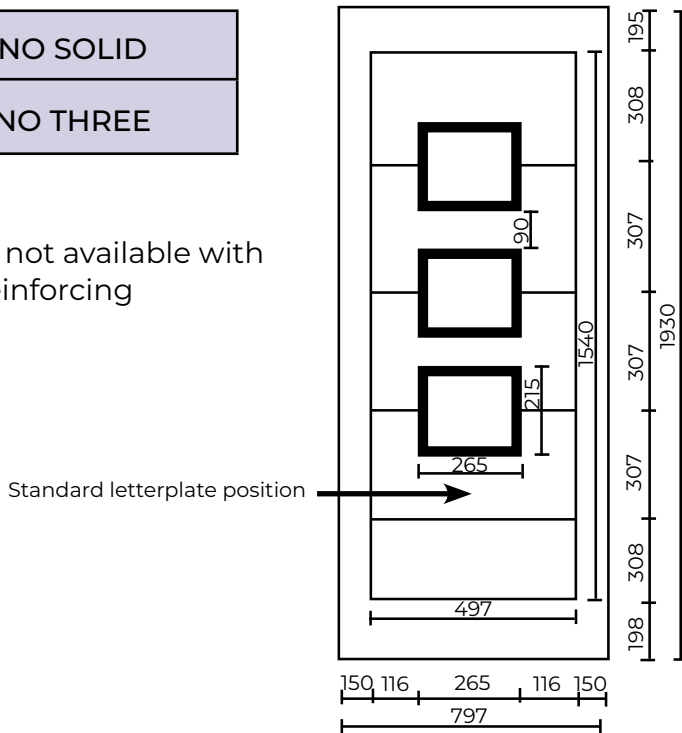

- Minimum Cut Size
- 547mm x 1590mm\*

\*Minimum height 1665mm with letterplate (under border)

- Glass Size
- 203mm x 152mm
- Sight Line
- 171mm x 121mm

# PROVENCE

- PROVENCE SOLID
- PROVENCE SIX

**Please note;**

- 2 glass units only

The following will cause the panel to exceed U-value of 1.4;

- Solid MDF reinforcing
- 8mm MDF reinforcing
- 12mm MDF reinforcing
- 24mm Thickness

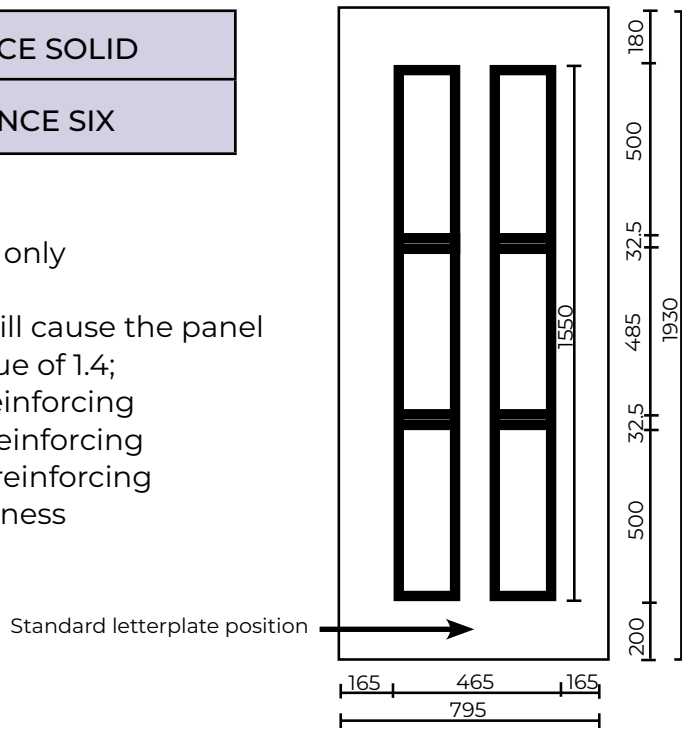

- Minimum Cut Size
- 505mm x 1600mm\*

\*Minimum height 1690mm with letterplate (bottom only)

- Glass Size
- 120mm x 1485mm
- Sight Line Top & Bottom
- 99mm x 446mm
- Sight Line Middle
- 99mm x 461mm

# REIMS

REIMS SOLID  
REIMS ONE

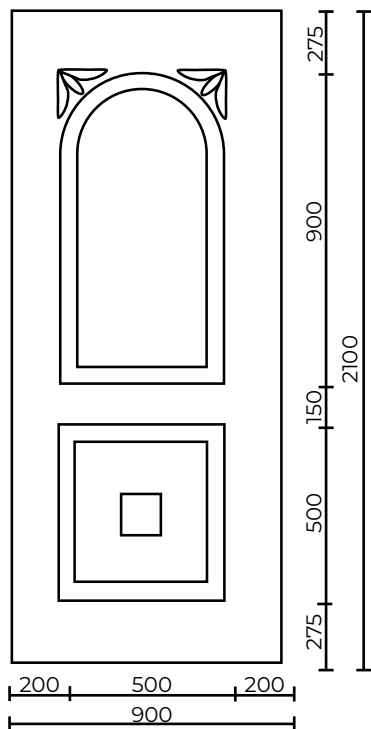

Minimum Cut Size  
550mm x 1600mm

Glass Size  
425mm x 825mm  
Sight Line  
395mm x 790mm

# REIMS SIDE

REIMS SOLID SIDE  
REIMS ONE SIDE

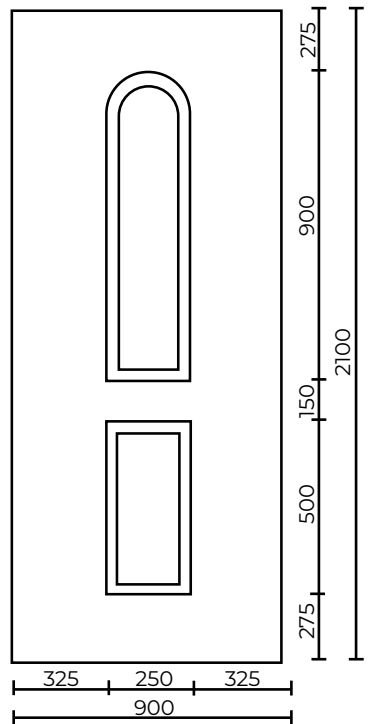

Minimum Cut Size  
300mm x 1600mm

Glass Size  
185mm x 845mm

# RICHMOND

RICHMOND SOLID  
RICHMOND ONE

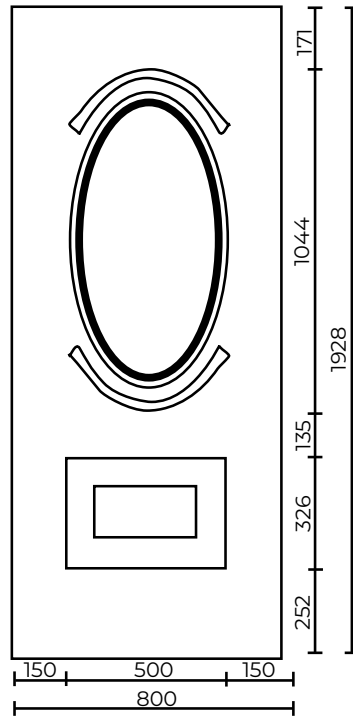

Minimum Cut Size  
550mm x 1555mm

Glass Size  
421mm x 837mm  
Sight Line  
370mm x 785mm

# ROCKINGHAM

ROCKINGHAM SOLID  
ROCKINGHAM ONE

Please note;

- Also available in Euro size - 900 x 2100
- Bottom moulding is not a match to another panel

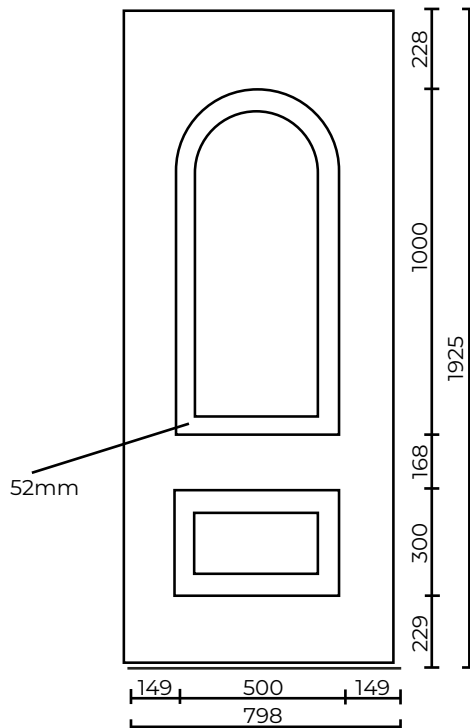

Minimum Cut Size  
550mm x 1520mm

Glass Size  
375mm x 885mm  
Sight Line  
345mm x 840mm

# ROME

ROME SOLID
ROME ONE

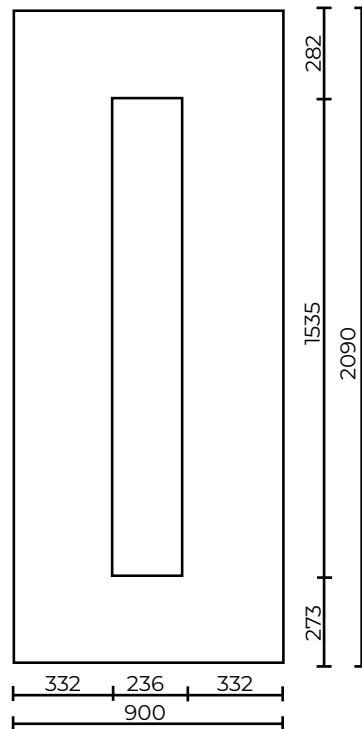

Minimum Cut Size
286mm x 1585mm*

\*Minimum height 1700mm with letterplate

Glass Size
180mm x 1485mm

Sight Line
135mm x 1425mm

# SANDRINGHAM

SANDRINGHAM SOLID
SANDRINGHAM ONE
SANDRINGHAM THREE
SANDRINGHAM FIVE

Please note;

- Also available in Euro size - 900mm x 2100mm
- Mouldings match the Manor panels

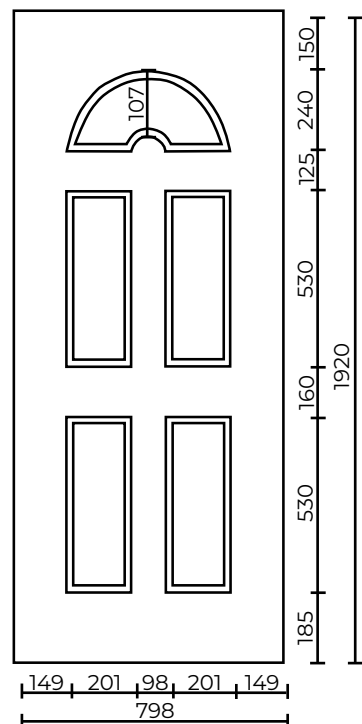

Minimum Cut Size
550mm x 1635mm

Glass Size Top
440mm x 178mm

Glass Size Middle
135mm x 465mm

Glass Size Bottom
135mm x 465mm

Sight Line Top
385mm x 107mm

Sight Line Middle
110mm x 438mm

Sight Line Bottom
110mm x 438mm

## SANDRINGHAM SIDE

SANDRINGHAM SOLID SIDE
SANDRINGHAM ONE SIDE
SANDRINGHAM TWO SIDE
SANDRINGHAM THREE SIDE

Please note;

- 20mm thickness not available

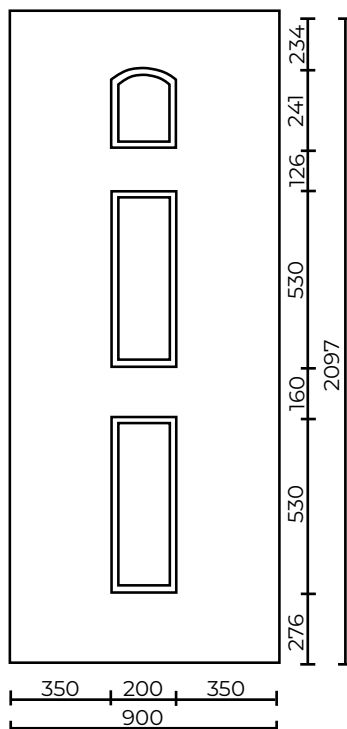

Minimum Cut Size
250mm x 1635mm
Glass Size Top
135mm x 180mm
Glass Size Middle
135mm x 465mm
Glass Size Bottom
135mm x 465mm
Sight Line Top
110mm x 153mm
Sight Line Middle
110mm x 438mm
Sight Line Bottom
110mm x 438mm

## SEVILLE

SEVILLE SOLID
SEVILLE ONE

Please note;

- This panel must be reinforced
- One piece sealed glass unit, not individual pieces
- 20mm available but not advised

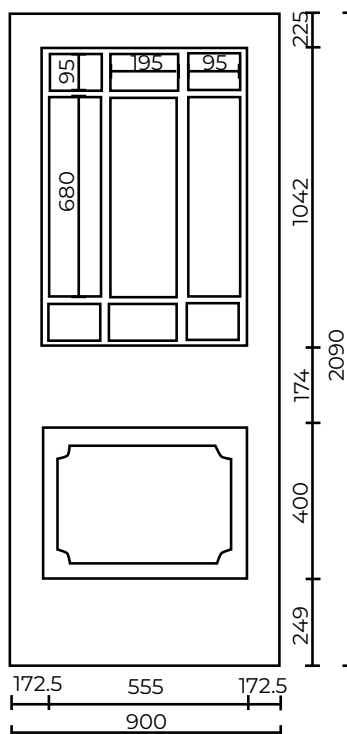

Minimum Cut Size
605mm x 1666mm

Glass Size
502mm x 985mm

# SORRENTO

- SORRENTO SOLID
- SORRENTO THREE

Please note;

- Not available with solid MDF

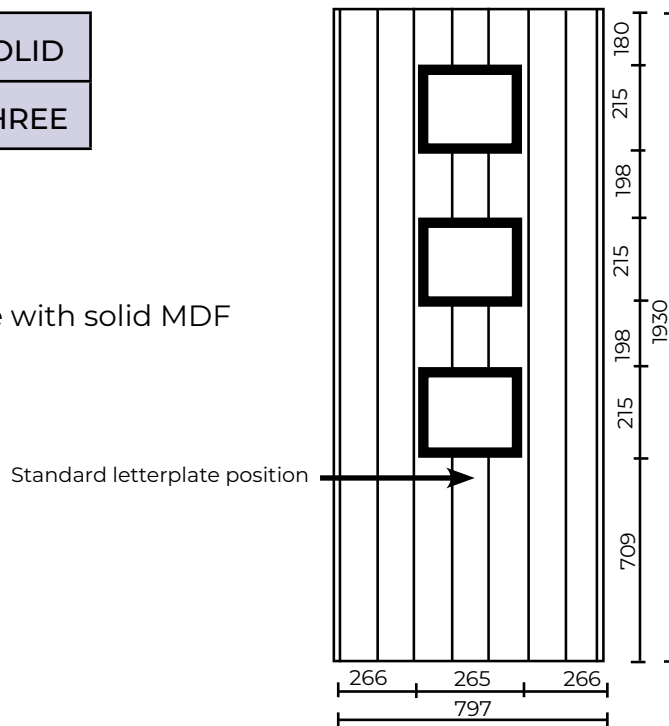

- Minimum Cut Size
- 315mm x 1090mm\*

\*Minimum height 1215mm with letterplate (under glass)

- Glass Size
- 203mm x 152mm
- Sight Line
- 171mm x 121mm

# TURIN

- TURIN SOLID
- TURIN ONE
- TURIN TWO

Please note;

- Not available with solid MDF

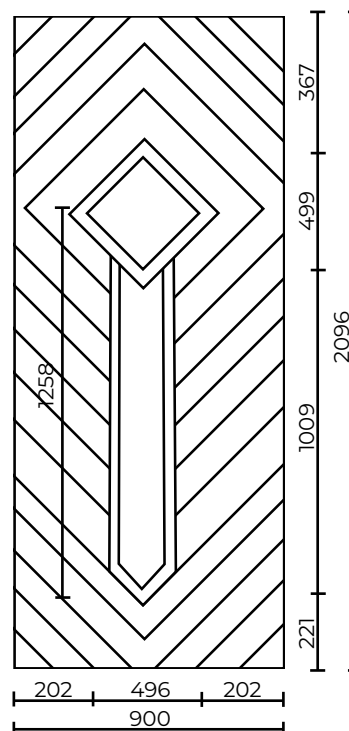

- Minimum Cut Size
- 550mm x 1560mm

- Glass Size Top
- 295mm x 295mm
- Glass Size Bottom
- 162mm x 1039mm
- Sight Line Top
- 340mm x 340mm
- Sight Line Bottom
- 120mm x 910mm

# WENDLAND

WENDLAND SOLID
WENDLAND ONE
WENDLAND TWO

**Please note;**

- Wendland has different moulds to the Balmorals

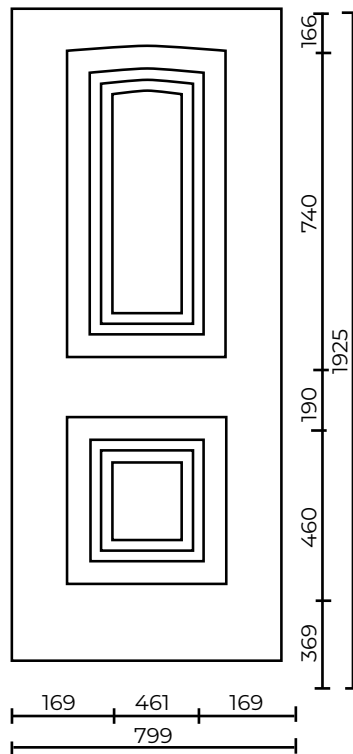

<b>Minimum Cut Size</b>
510mm x 1435mm

<b>Glass Size Top</b>
360mm x 640mm

<b>Glass Size Bottom</b>
360mm x 360mm

<b>Sight Line Top</b>
330mm x 610mm

<b>Sight Line Bottom</b>
325mm x 325mm

# WINDSOR

WINDSOR SOLID
WINDSOR TWO
WINDSOR FOUR
WINDSOR SIX

**Please note;**

- Also available in Euro size - 900mm x 2100mm
- 20mm thickness not available
- Available inverted except Euro size
- Mouldings match Manor panels

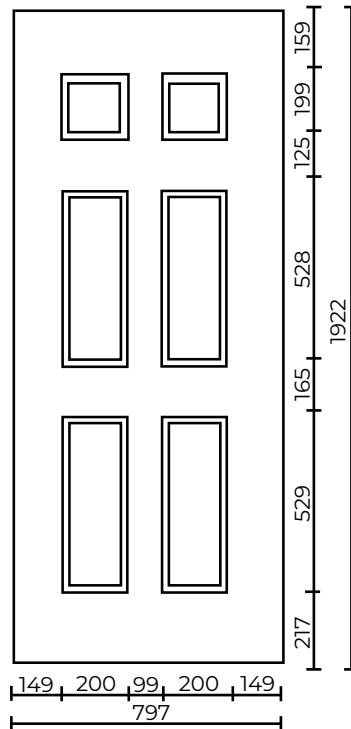

Minimum Cut Size
550mm x 1590mm
Glass Size Top
140mm x 140mm
Glass Size Middle
135mm x 465mm
Glass Size Bottom
135mm x 465mm
Sight Line Top
110mm x 110mm
Sight Line Middle
110mm x 438mm
Sight Line Bottom
110mm x 438mm

# WINDSOR SIDE

WINDSOR SOLID SIDE
WINDSOR ONE SIDE
WINDSOR TWO SIDE
WINDSOR THREE SIDE

**Please note;**

- Not available inverted
- 20mm thickness not available

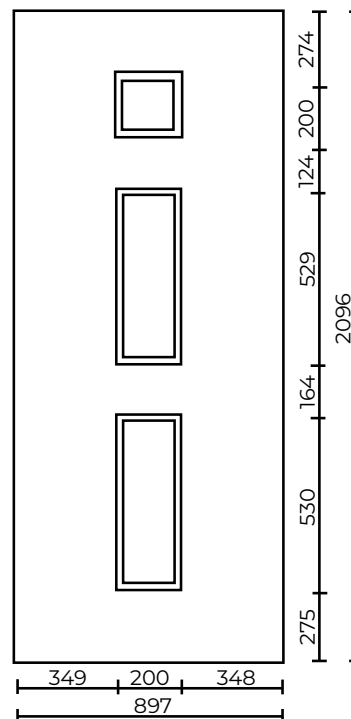

Minimum Cut Size
250mm x 1590mm
Glass Size Top
140mm x 140mm
Glass Size Middle
135mm x 465mm
Glass Size Bottom
135mm x 465mm
Sight Line Top
110mm x 110mm
Sight Line Middle
110mm x 438mm
Sight Line Bottom
110mm x 438mm

HALF  
PANELS

## ABBEY HALF

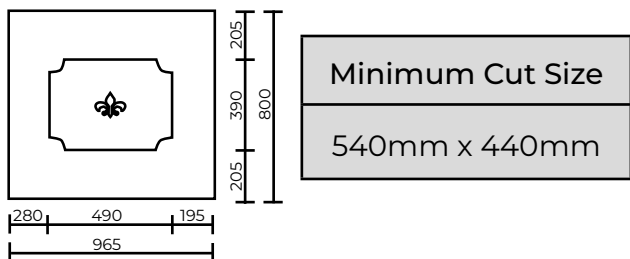

## BUCKINGHAM HALF

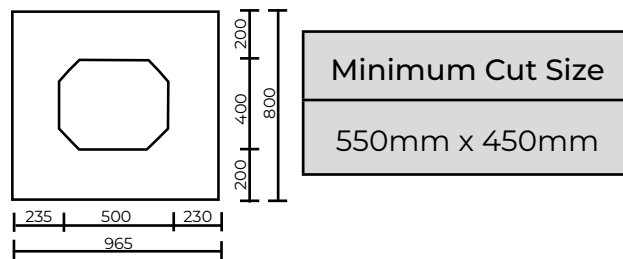

Please note; Horizontal grain only

## MANOR HALF

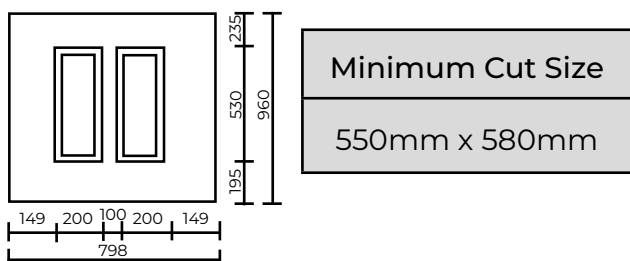

Please note;

- Also available with 460 mouldings from the Manor Triple
- Grain runs vertically not horizontally, these will be supplied as standard unless clearly specified otherwise.

## MANOR HALF INVERTED

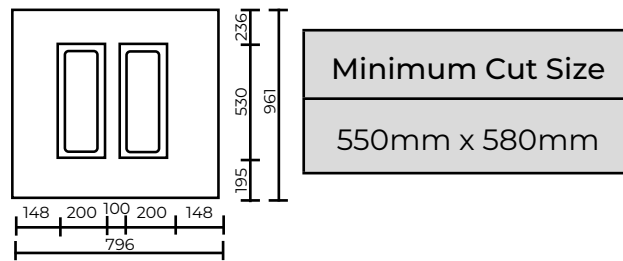

Please note;

- Grain runs vertically not horizontally, these will be supplied as standard unless clearly specified otherwise.
- 20mm thickness not available
- Does not match: Sandringham/ Kensington/ Windsor

## HANOVER HALF

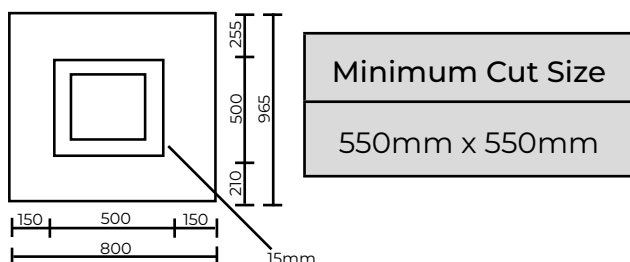

Please note; Moulding matches Winchester

## HANOVER HALF SLIMLINE

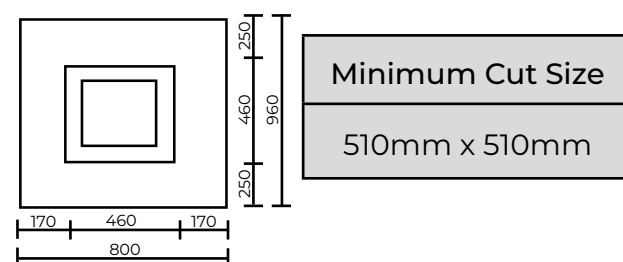

Please note; Also available with 460 mouldings from the Hanover Triple

## WESTMINSTER HALF

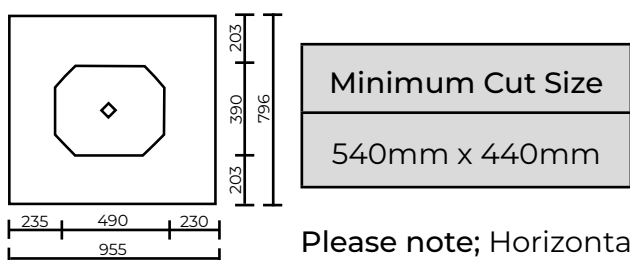

Please note; Horizontal grain only

# QUARTER PANELS

## ELIZABETHAN QUARTER

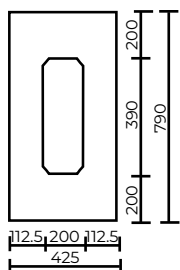

Minimum Cut Size  
250mm x 440mm

- Please note;**
- Only available from a Elizabethan conservatory full sheet

## WINCHESTER QUARTER

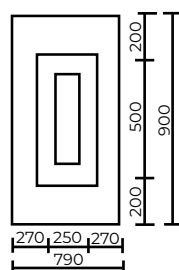

Minimum Cut Size  
300mm x 550mm

- Please note;**
- Mouldings match Hanover panels (except triple)

## MANOR QUARTER

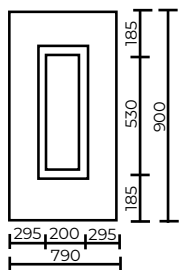

Minimum Cut Size  
250mm x 580mm

## CATHEDRAL QUARTER

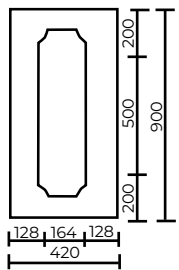

Minimum Cut Size  
210mm x 550mm

- Please note;**
- Only available from a Cathedral conservatory full sheet

# CONSERVATORY PANELS

## ABBEY CONSERVATORY

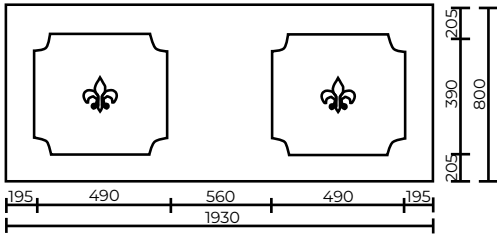

Minimum Cut Size

1590mm x 445mm

## BUCKINGHAM CONSERVATORY

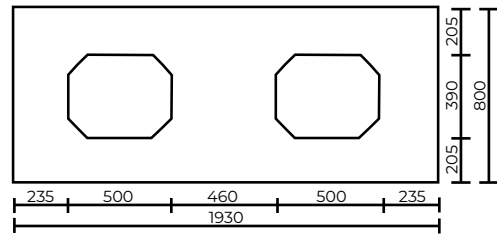

Minimum Cut Size

1510mm x 440mm

## CATHEDRAL CONSERVATORY

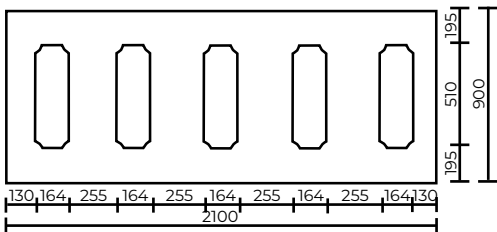

Minimum Cut Size

1890mm x 550mm

## ELIZABETHAN CONSERVATORY

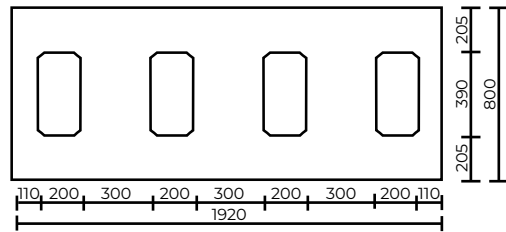

Minimum Cut Size

1750mm x 440mm

## HANOVER CONSERVATORY

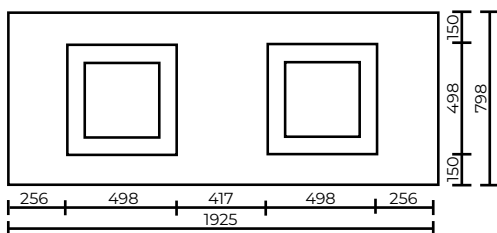

Minimum Cut Size

1470mm x 550mm

**Please note;**

- Also available with 460mm mould width

## HANOVER TRIPLE

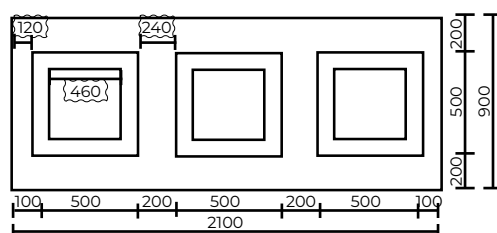

Minimum Cut Size

1950mm x 550mm

**Please note;**

- Also available with 460mm mould width
- Mouldings do not match Hanover Half

Please note; When having Woodgrain/Colourgrain applied to conservatory panels, the grain runs horizontally, not vertically.

## MANOR CONSERVATORY

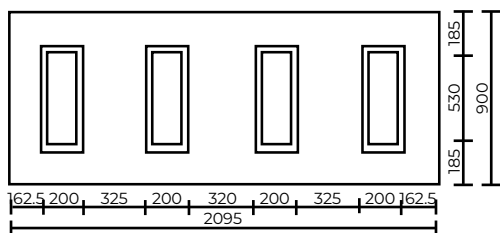

Minimum Cut Size

1825mm x 580mm

## MANOR TRIPLE

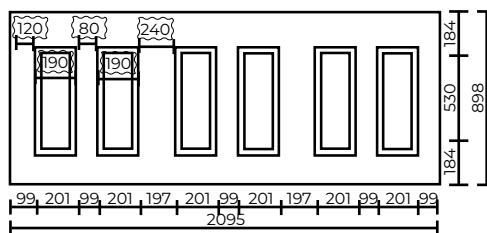

Minimum Cut Size

1950mm x 580mm

Please note;

- Also available with 460mm mould width

## MANOR FULL

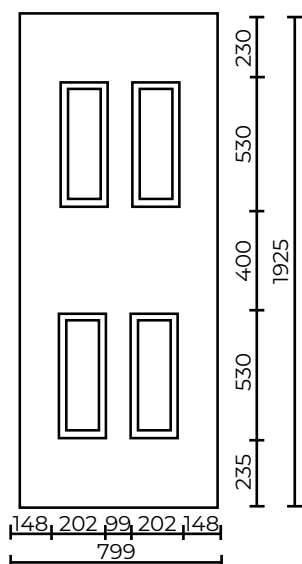

Minimum Cut Size

550mm x 1510mm

Please note;

- Available inverted
- 20mm thickness not available when inverted

## WESTMINSTER CONSERVATORY

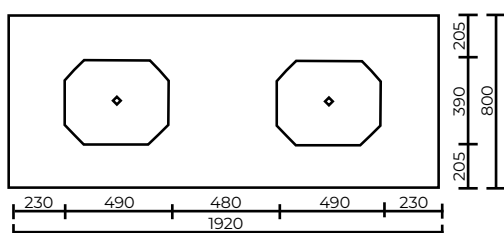

Minimum Cut Size

1510mm x 440mm

## WINCHESTER CONSERVATORY

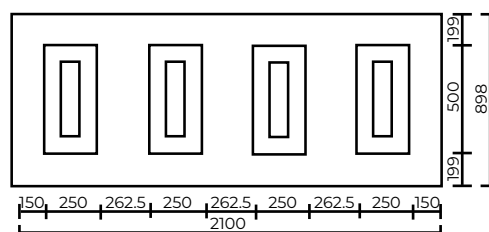

Minimum Cut Size

1845mm x 550mm

Please note; When having Woodgrain/Colourgrain applied to conservatory panels, the grain runs horizontally, not vertically.

## SHIPLAP

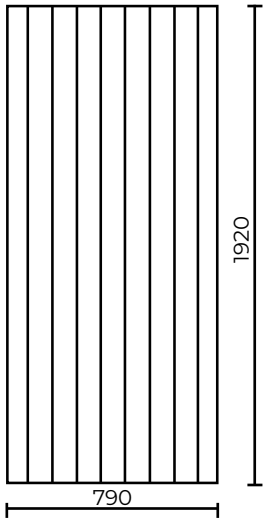

### Please note;

- Also available in Euro size - 900mm x 2092mm
- Groove size 80mm/10mm
- Groove depth 5mm
- The moulding is slightly deeper in Euro sized panels
- Max width of 430mm if 2 panels are to be cut from euro sized panel

## HERRINGBONE

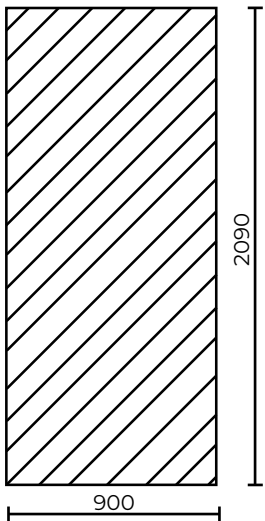

### Please note;

- Mouldings do not match Hamburg panel
- Groove depth 5mm

## DECLAP

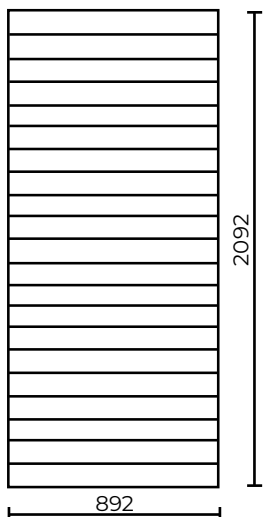

### Please note;

- Groove size 77mm/14mm
- Groove depth 5mm

## FLAT PANELS

Size	Available Woodgrain	Available Colourgrain
1500mm x 3000mm	No	No
900mm x 2100mm	Yes	Yes
900mm x 1040mm	Yes	Yes
440mm x 2100mm	Yes	No
440mm x 1040mm	Yes	No

### Please Note;

- On grained flat panels the grain runs vertically
- Woodgrains and Colourgrains are sold with 4mm MDF reinforcing as standard

### Woodgrain Door Panels

All Woodgrain and Colourgrain panels feature 'heat-reflective' technology - an advanced technical process designed to significantly reduce the effect of UV light on darker surfaces thereby improving stability.

Hurst Doors have also introduced a system of venting the moulds which allows the expanding air to escape, thus reducing the occurrence of de-lamination and cracking.

An adhesive is also used which has a higher co-efficient of expansion, greater elasticity properties and better adhesion qualities. Due to the nature of this product we strongly recommend that woodgrain door panels are not exposed to strong sunlight.

## MDF & THICKNESS OPTIONS

	CM1 - Full Poly	CM3 - 4mm MDF	CM16 - Solid MDF	CM17 - 8mm MDF	CM18 - 12mm MDF	CM22 - Poly/4mm Securicore™/ Poly
3000mm x 1500mm	20mm 24mm 28mm	20mm 24mm 28mm		24mm 28mm	28mm	20mm 24mm 28mm
900mm x 2100mm	20mm 24mm 28mm 18mm	20mm 24mm 28mm 19mm	20mm 24mm 28mm	24mm 28mm	28mm	20mm 24mm 28mm
900mm x 1040mm	24mm 28mm	24mm 28mm				
440mm x 2100mm	24mm 28mm	24mm 28mm				
440mm x 1040mm	24mm 28mm	24mm 28mm				

## ANCILLARIES

	Gold	Chrome	Black	Satin Chrome	White	Bright Bronze	Graphite
Letterbox	Yes	Yes	Yes	Yes	Yes		
Premium Letterbox	Yes	Yes	Yes	Yes	Yes	Yes	Yes
Urn Knocker	Yes	Yes	Yes	Yes	Yes	Yes	Yes
Slimline Urn Knocker	Yes	Yes	Yes		Yes	Yes	Yes
Urn Knocker with Spyhole	Yes	Yes	Yes	Yes	Yes	Yes	Yes
Slimline Urn Knocker with Spyhole	Yes	Yes	Yes		Yes	Yes	Yes
Spyhole	Yes	Yes	Yes	Yes	Yes		
Lion's Head Knocker (70mm)	Yes		Yes				
Numerals	Yes	Yes	Yes	Yes			

	UAP	Fab & Fix
Router Size	48mm x 264mm	48mm x 264mm
Letterbox Size	65mm x 300mm	68mm x 310mm

# GLASS GUIDE



## HARMONY GLASS COLLECTION

- Clear and sandblasted glass to both sides
- No backing glass required



## MODERN TRIM COLLECTION

- Obscure backing glass required



## CLASSIC GLASS COLLECTION

- Obscure backing glass required



## HERITAGE GLASS COLLECTION

- Sandblasted face with your choice of backing glass (clear recommended)
- Resin designs obscure backing glass required
- Film & lead designs, obscure backing glass required



## BEVEL GLASS COLLECTION

- Sandblasted face with bevels, your choice of backing glass (clear recommended)
- Film, lead & bevel designs, obscure backing glass required



## CRYSTAL GLASS COLLECTION

- Crystal bevels encased inside the glass, no backing glass required



## PLATINUM GLASS COLLECTION

- Bevel design encased inside the glass, no backing glass required

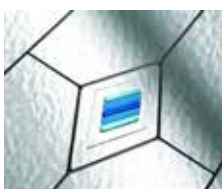

## FUSED JEWELS COLLECTION

- Resin design with fused on jewel tiles, your choice of backing glass

## BACKING GLASS OPTIONS

Clear	Minster	Oak
Stippolyte	Arctic	Pelerine
Autumn	Chantilly	Sandblasted*
Everglade	Charcoal Sticks	Taffeta
Flemish	Florielle	Warwick*
Sycamore	K Glass*	Satin*
Contora	Laminate*	Bronze Anti Sun*
Cotswold	Mayflower	Cassini/Tribal

Platinum units must be reinforced (\*Surcharge applies)

## RESTRICTED BACKING GLASS OPTIONS

Hurst Doors follow the rules and regulations of the Glass and Glazing Federation. As such, all glass supplied in our door panels must be either 4mm toughened or 6mm untoughened.

Unfortunately, the glass market does not offer a small number of our glass patterns in either due to size and popularity.

The panels affected areas follows:

- Sandringham Side
- Windsor 2
- Windsor Side
- E5034
- E5065
- E5113
- E5123
- Amalfi 4

Available glass options for the above are:

- Clear
- Autumn
- Cotswold
- Stippolyte
- Sycamore
- Sandblasted\*
- Satin\*

\*Surcharge applies

To summarise

- Glass in door panels must be either 4mm toughened or 6mm untoughened.
- Small pieces of 4mm glass cannot be toughened.
- Not all patterns are available in 6mm glass.

## WOODGRAIN OPTIONS



## COLOURGRAIN OPTIONS

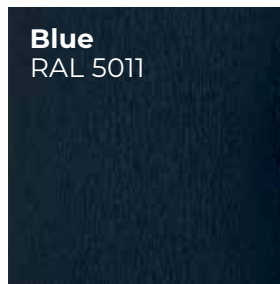
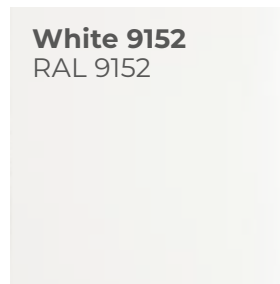
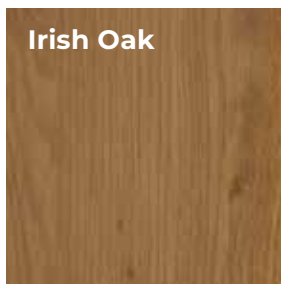

Georgian Bars now available in Chartwell Green and Anthracite Grey.











**Enquiries:**  
Call 01482 790790  
Visit [Hurstdoors.co.uk](https://www.hurstdoors.co.uk)



With reference to product descriptions, colours, styles and features, every effort is made to ensure that the products that we supply correspond as closely as possible to the examples shown in this brochure. Due to the limitations of the photographic and printing processes, colour illustrations should be used as a guide only. Due to a continuous development programme, Hurst Plastics Ltd (Hurst) reserve the right to alter specifications without prior notice. All specifications are correct at the time of going to print. E & OE. This brochure and all content including copy, images and information is the Copyright © of Hurst Plastics Ltd (Hurst Doors) and protected under UK law.